

SOTRAS

**Filters & Products for Compressors,
Vacuum Pumps and Compressed Air**



SUMMARY

<i>Product quality supported by efficient service</i>	<i>pag.2</i>
<i>Research & Development</i>	<i>pag.6</i>
<i>Testing</i>	<i>pag. 8</i>
<i>Filters & Products for Compressors</i>	<i>pag. 12</i>
<i>Air Oil Separators</i>	<i>pag.14</i>
<i>Standard Separators</i>	<i>pag.18</i>
<i>Spin-On Separators</i>	<i>pag.22</i>
<i>Filter Heads & Adapters</i>	<i>pag.24</i>
<i>Air Filters</i>	<i>pag.26</i>
<i>Plastic Air Cleaners</i>	<i>pag.30</i>
<i>Spin-On Oil Filters</i>	<i>pag.32</i>
<i>Filters & Products for Vacuum Pumps</i>	<i>pag. 34</i>
<i>Standard Demisters</i>	<i>pag.36</i>
<i>Vacuum Air Filters</i>	<i>pag.38</i>
<i>Filters & Products for Vacuum and Compressed Air</i>	<i>pag. 40</i>
<i>Compressed Air Filters</i>	<i>pag.42</i>
<i>Accessories & Kits</i>	<i>pag.44</i>
<i>Practical Advice</i>	<i>pag.45</i>
<i>Quality and Guarantee</i>	<i>pag.48</i>

Product quality supported by efficient service

Sotras was founded in 1975 as a trading business and over the years has transformed itself into an important brand manufacturing industrial filters, making and distributing its own products in Europe and throughout the world.

Today Sotras can supply a top quality range of industrial filters and has specialized in manufacturing elements for compressors, vacuum pumps and compressed air applications to suit most requirements in these fields.

In particular, Sotras can boast established experience and skill in designing and manufacturing high quality air/oil separators specifically for installation in rotary screw and vane compressors.

We guarantee that all materials used for our products undergo stringent

quality tests and specific treatments which ensure long life span and reliable performance.

In fact, Sotras' mission is to provide products and services of the highest quality to satisfy specific needs and requirements of the market.

From the beginning, Sotras has strived for perfection focusing on innovation, reliability and safety of the products as well as by giving

Head Quarters



particular attention to human resources training, making them able to contribute, individually or collectively, to the attainment of the objectives of the business.

Sotras employees, in Technical and Commercial Departments, are able to establish lasting relationships with our customers by meeting their expectations through their personal and organizational skills.

In the same way, thanks to its experience gained from many years dealing with filtration in the compressed air industry, Sotras has developed a flexible product handling system allowing the Logistic Department to satisfy requirements in terms of variety, quality and speed.

Commercial and production sites are located in Borgaro Torinese (Torino) covering an area of about 11,000 m². Sotras headquarters, production premises and logistics department are less than 10 minutes from the Turin Caselle International Airport.



Product quality supported by efficient service

A new company, Sotras Logistica, was set up in 2006 to manage the logistics activity of the finished products which are stocked in a modern warehouse of some 4,000 m². The site is the very heart of our products handling where all the orders are processed and to which all customers refer to as the Sotras logistics centre.

The new structure has allowed a rationalization of organization and activities and has provided additional space for stocking and handling. The premises are strategically located near to Sotras headquarters, Turin Airport and major transport routes.

Sotras Logistica



Twelve years ago Sotras took its first steps in the market in China and since then has succeeded in acquiring local OEMs as important customers.

It soon became evident that it had to meet local customers' requirements for prompt deliveries so obviously the step was to form a subsidiary logistics company to fulfil this need.

Excellent results have been achieved over the years and thanks to this and in response to OEMs constant requests, we are proud to announce that Sotras China has now opened a production site as well as a strategic logistics center, dedicated to the market in China.

Sotras China (Shanghai)



Research & Development

R&D commitment is to handle the know-how, to stimulate new ideas, looking into the future to respond to its challenge by developing and enhancing the human resources, to be able to compete with an economy more and more characterized by knowledge. In fact, Sotras technicians are required to play an active role of co-operation with the company management, having a key responsibility in translating the strategic view into resalable products and services of value.

Over the years Sotras has made considerable investments in the field of process engineering. It has arranged for and designed in house special tooling as well as unique machines and equipment for the different stages of working process which are constantly monitored in order to ensure a

safe and correct manufacturing and use of the product.

With a view to constant improvement, Sotras has been deeply involved in the research for new materials as well as new process solutions and products, which has led to a contextual progress in tests and modifications that have played an important part in the quality and safety of the products.



The systematic adhesion to ISO 9000 regulation, following its various evolutions since 1999, has led the company's attitude to follow a methodical approach to processes.

Through this evolution we have assisted our customers in product analysis and performance not only for processing checks but also during the study and designing stages.

Moreover, a typical difficulty we have to face in our sector lies in the simulation or prediction of the working conditions under which our products will be used - in circuits and machines offering countless different possibilities and hundreds of variables. Therefore, to define the concrete and real performance of the product, we have concentrated on the research of analysis methods

which enable us to anticipate the possible defectiveness of a product and to prevent problems.

The outcome of this activity has been a tangible increase in the reliability and efficiency of our products through improved manufacturing processes and this has resulted in more competitiveness and satisfaction in our market.

Evidence of the excellent level of quality of our products, lies also in the fact that Sotras supplies high performance solutions where high reliability is required such as in the railways sector.

In its ambition to provide first class care to its customers, Sotras runs technical training courses for their own staff as well as for distributors and customers themselves.



Testing

For years now, checks on all incoming products and 100% of the outgoing finished products are ruled by a Control Plan deriving from ISO TS 16949 for the automotive sector. This document, which is constantly updated, indicates the control and related procedures of every step of the process and every characteristic of the product, including the project validation stages both of the actual process and of the products.

The investments in this sector have made it possible to improve and add new tooling and diagnostic instruments for each characteristic. This has enabled us to test new components, new materials and new manufacturing solutions with more precision. Our target has been to achieve the improvement of our product performance as well as efficiency

and reliable repeat production. A special device has been designed (see side picture below) that allows us to test the collapse or explosion resistance limits of our products under extreme working conditions at variable flow rates and at limit pressures. This makes it possible for us to confirm the performance level of our products and to find the best possible solutions in terms of materials employed.



Owing to the extreme variability of production volumes and to the sizes of our products, a very high level of flexibility and strict attention to the management of the quality process has had to be instigated. Some defects are not always visible to the naked eye and they can compromise the functionality of the element.

In addition, laboratory devices have been used for the preventive analysis of production batches through simple but effective non destructive tests, such as the smoke test (see side picture below), in order to detect product as well as process defects. From the perspective of preventive management of defects, we have attained a substantial level of quality and reliable repeatability in production. Also as a consequence of the process reliability

attained, we have rationalized the required checks and reduced the less necessary tests. Based on ISO 8573-2, using Johnson and Balston Tests we regularly check the residual aerosol oil content (ppm) in order to guarantee this filtering performance on our products.



Testing

Another important test that is systematically carried out and applied to every production batch, concerns the stress analysis of the materials of our spin-on filters (see small pictures below). This test has a twofold value: the quality analysis of materials and processes and, of utmost importance, the analysis of the safety conditions of the products in compliance with the current European regulations and guidelines.

For many years our Technical department has given our customers support regarding claim analysis and returned goods for perceived defectiveness of the product.

Tests simulating working conditions and those carried out on returned products (see small pictures below) provide information in the study of

possible root causes.

This analysis and diagnostic service has allowed us to highlight and correct process anomalies and defects, leading to improvements in the choice and control of components at their origin. And, very often, to be able to suggest to our customers an alternative method of installing the filters and the conditions of servicing.









Filters & Products for Compressors

Air Oil Separators

During the last century compressed air became associated with many industrial applications and compressor manufacturers focused their attention on rotary screw and vane compressors whose compression systems use lubricating oil as a coolant. Hence the necessity of using air/oil separators.

Sotras designs and manufactures separators specifically for installation in rotary screw and rotary vane compressors and they are available in vertical, horizontal and spin – on configurations.

Their purpose is to separate the oil droplets from the compressed air, thereby producing cleaner air and allowing the oil to be scavenged and re-circulated in the compressor.

Sotras separators are manufactured to satisfy OEM's need in terms of .:

- *Physical principle of air/oil separation.*
- *Element dimensions according to the compressor's performance and tank dimensions.*
- *Oil consumption to ensure a correct functional performance.*
- *Use of high grade filtration and separation media to ensure the best quality of clean air needed for industrial applications. Additionally it is very important to highlight that Sotras separators can be used with all types of oils, whether standard, mineral based, synthetic or partially synthetic.*

In order to decide which is the best separator to be used for a specific compressor. OEMs have to consider what level of separation needs to be achieved, in other words to target the minimum parts per million of residual oil content required.



For this a technical solution is need in order to reduce the oil concentration in the air. Often OEMs needed to consider a pre-separation system, which will reduce the PPM and increase the life of the air/oil separator.

CONSTRUCTION

Corrosive resistant materials are used in the construction of the air/oil separators. Careful welding procedures and the use of the latest twin pack adhesive ensure that the element has high mechanical strength and can endure operating temperature up to 120°C. Sotras has also developed special technologies formulated to make air/oil separators withstand extreme environmental conditions such as high humidity and salinity levels.

In fact, we are able to offer high performance solutions for high reliability applications such as railways, in terms of stainless steel air/oil separators, air filters and oil filters.

SEPARATION - PRESSURE DROP - EFFICIENCY - PERFORMANCE

Normally, the air and oil mixture passes from the outside to the inside of the separator and the coalescing effect is carried out through a multi

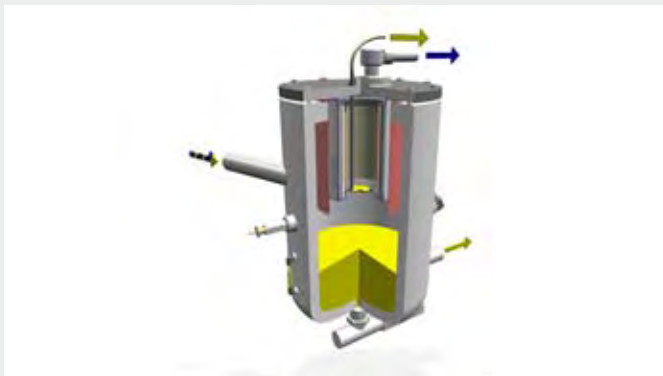

Air Oil Separators

stage separation process resulting in the recovery of the oil and producing clean air.

At a nominal working pressure of 7 bar, the pressure drop on a new element varies between approximately 0.15 and 0.25 bar.

At other working pressures, the pressure drop is proportional to the air velocity across the separator (graph 2). By using our separators, the oil carryover after separation is limited to about 1 to 3 ppm (graph 1). The life of the separator depends on many factors: the designs and regular maintenance of the compressor, clean environment, working temperature, quality of the air and oil filters.



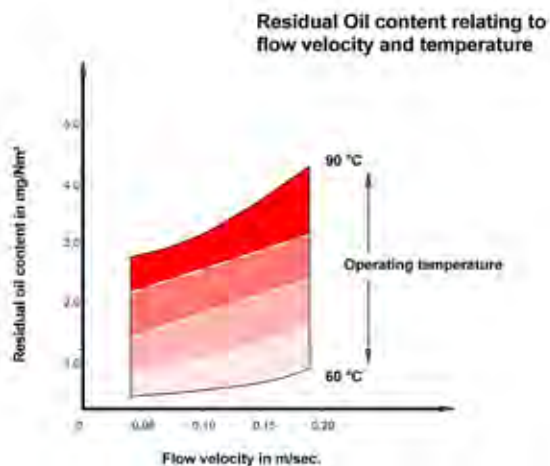

To ensure maximum separator efficiency, the joints must create a perfect seal. Experience has shown that through correct installation and also using the correct type of oil, Sotras' air/oil separators can have a life expectancy of many thousands of hours. Sotras' air/oil separators can offer different separation solutions according to manufacturers' requirements.

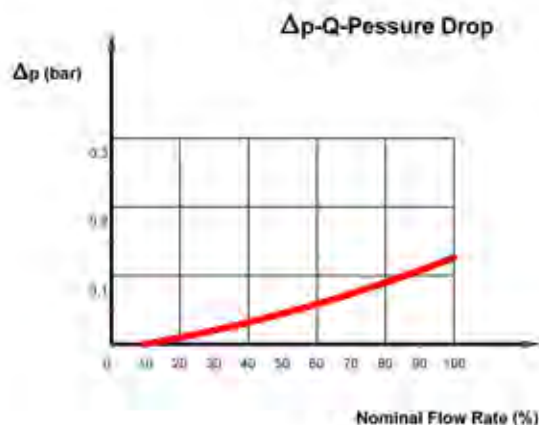

graph 1

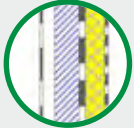

graph 2

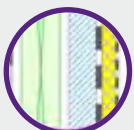
	<i>Fig.</i>	<i>Type</i>	<i>Pressure drop @ nominal flow rate (bar)</i>	<i>General specification</i>
1		<i>Single wrapped</i>	<i>0,16</i>	<i>Low production costs, good performance on small dimension or long life span</i>
2		<i>Double wrapped</i>	<i>0,18</i>	<i>Excellent performance on small dimension or long life span</i>
3		<i>Pleated</i>	<i>0,15</i>	<i>Low pressure drop</i>
4		<i>Whit pre-separation Fleece</i>	<i>0,20</i>	<i>For application showing high oil percentage before separation or under particular environmental conditions</i>
5		<i>Pleated+Wrapped</i>	<i>0,17</i>	<i>Low pressure drop and excellent separation level</i>



Standard Separators

The following tables show only a short list of Sotras standard range of separators.

We must emphasize that we are constantly designing and manufacturing specific customized types and we are pleased to receive enquiries for this service.

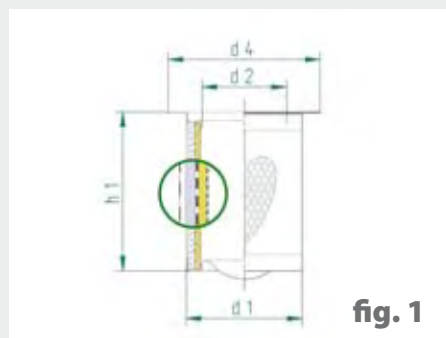

fig. 1

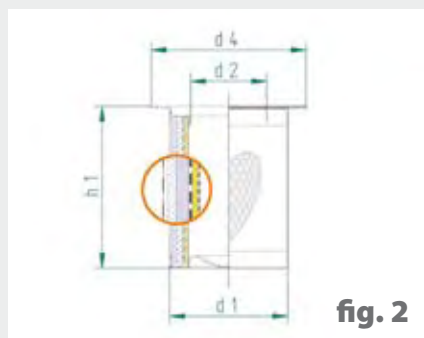

fig. 2

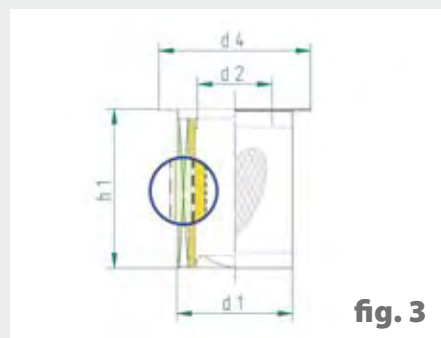

fig. 3

*The data is indicative and based on 7 bar working pressure

SOTRAS Ref.	*Nominal flow Rate		Fig.	d1 (mm)	d2 (mm)	d4 (mm)	h1 (mm)	h2 (mm)
	m ³ /min	(cfm)						
DB 2073	1,3	46	1	170	122	200	100	12
DB 2067	1,4	49	1	125	76	165	140	0
DB 2001	1,5	53	1	135	88	165	140	12
DB 2521	1,8	63	4	110	60	165	100	0
DB 2002	2	70	1	135	88	170	200	12
DB 2059	2,1	74	1	110	60	154	228	0
DB 2071	2,2	77	2	135	75	170	110	0
DB 2004	2,2	77	1	170	122	200	160	12
DB 2058	2,3	81	4	110	60	165	250	0
DB 2472	2,4	84	2	135	75	165	120	0
DB 2566	2,5	88	2	100	41	142	150	0
DB 2046	3,2	113	4	170	122	196	217	0
DB 2003	3,5	123	1	135	88	170	305	12
DB 2006	3,5	123	1	170	122	200	230	12
DB 2057	3,5	123	2	135	75	170	160	0
DB 2564	4,2	148	2	125	64	170	200	0
DB 2009	4,5	158	1	170	122	200	305	12
DB 2074	4,5	158	2	135	75	170	200	0
DB 2085	5	176	2	170	108	200	180	0
DB 2115	5,2	183	4	135	75	165	230	0
DB 2140	5,5	194	1	170	122	275	358	12
DB 2075	5,5	194	2	135	75	170	250	0
DB 2486	5,8	204	2	170	108	200	200	0

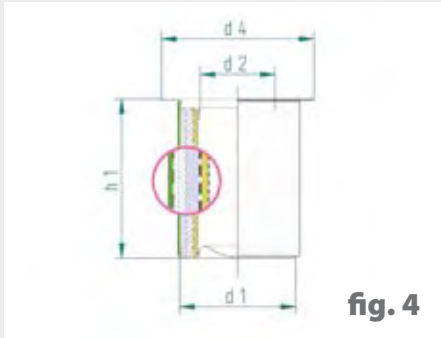

fig. 4

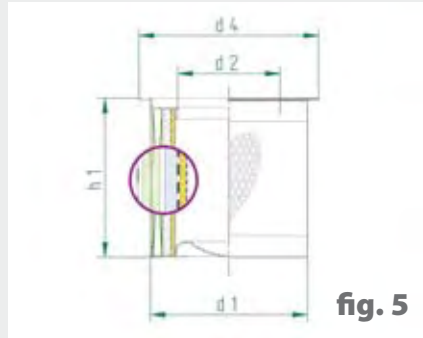

fig. 5

**The data is indicative and based on 7 bar working pressure*

SOTRAS Ref.	*Nominal flow Rate		Fig.	d1 (mm)	d2 (mm)	d4 (mm)	h1 (mm)	h2 (mm)
	m ³ /min	(cfm)						
DB 2103	5,8	204	2	220	157	273	160	0
DB 2013	6,4	225	1	220	165	273	318	12
DB 2021	6,5	229	1	275	219	328	250	0
DB 2093	6,7	236	2	220	157	273	180	0
DB 2012	6,7	236	1	170	122	200	435	12
DB 2160	7	246	4	170	108	200	230	0
DB 2186	7	246	2	170	108	200	230	0
DB 2123	7,2	253	2	135	75	170	305	0
DB 2022	7,7	271	1	275	219	328	305	12
DB 2018	8,5	299	1	220	165	273	430	12
DB 2105	9	317	2	220	157	273	230	0
DB 2319	9	317	3	220	157	273	230	0
DB 2473	9	317	2	275	210	296	190	0
DB 2132	9,5	334	2	170	108	200	305	0
DB 2077	9,8	345	4	220	157	288	250	0
DB 2128	11	387	2	170	108	200	350	0
DB 2156	11,5	405	2	170	108	200	380	0
DB 2020	12	422	1	220	165	273	600	12
DB 2024	12	422	1	275	219	324	448	12
DB 2104	12	422	2	220	157	273	305	0
DB 2131	12,3	433	2	275	210	328	250	0
DB 2026	12,5	440	1	300	243	348	445	12
DB 2188	12,5	440	2	170	108	200	400	0

Standard Separators

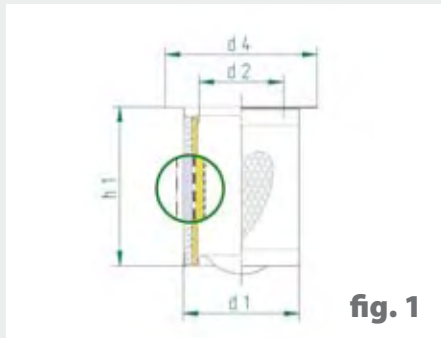

fig. 1

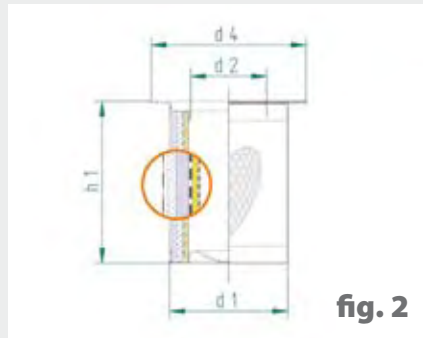

fig. 2

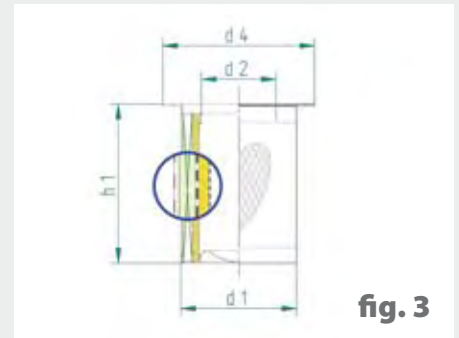

fig. 3

*The data is indicative and based on 7 bar working pressure

SOTRAS Ref.	*Nominal flow Rate		Fig.	d1 (mm)	d2 (mm)	d4 (mm)	h1 (mm)	h2 (mm)
	m ³ /min	(cfm)						
DB 2173	13,3	468	2	220	157	300	330	0
DB 2027	14	493	1	300	243	355	500	12
DB 2150	14	493	2	220	157	273	348	0
DB 2312	15	528	4	275	210	328	305	0
DB 2118	16	563	4	220	157	288	400	0
DB 2130	16,5	581	2	300	219	345	305	0
DB 2029	17	598	1	300	243	355	600	12
DB 2353	18	634	5	300	219	343	314	0
DB 2030	19	669	1	300	243	355	660	12
DB 2082	19,5	686	1	400	314	439	520	0
DB 2127	19,5	686	2	300	219	355	350	0
DB 2025	20	704	1	275	219	324	750	12
DB 2138	20	704	2	275	210	328	400	0
DB 2051	21,5	757	1	300	243	348	750	12
DB 2102	22	774	2	300	219	350	400	0
DB 2055	23,5	827	1	300	243	355	820	12
DB 2061	23,5	827	1	400	314	439	620	0
DB 2195	24	845	2	275	210	300	460	0
DB 2124	25	880	2	220	157	273	612	0
DB 2084	25,5	898	2	275	210	325	500	0
DB 2528	27	950	3	500	427	596	565	0
DB 2089	28	986	2	300	219	355	500	0
DB 2467	28	986	5	300	219	353	445	0

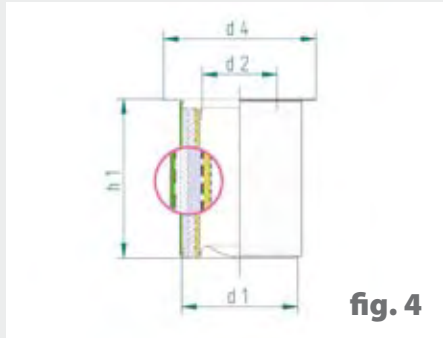

fig. 4

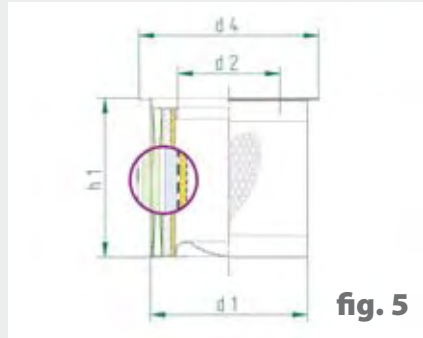

fig. 5

**The data is indicative and based on 7 bar working pressure*

SOTRAS Ref.	*Nominal flow Rate		Fig.	d1 (mm)	d2 (mm)	d4 (mm)	h1 (mm)	h2 (mm)
	m ³ /min	(cfm)						
DB 2147	29	1021	1	300	243	355	1000	12
DB 2556	34	1197	2	350	264	430	445	0
DB 2090	34,5	1214	2	300	219	355	600	0
DB 2525	38	1338	4	350	264	430	470	0
DB 2382	39	1373	5	393	304	439	510	5
DB 2167	39,5	1390	2	300	219	355	700	0
DB 2479	40	1408	2	400	314	434	520	0
DB 2126	43	1514	2	400	314	439	600	0
DB 2466	43	1514	2	350	264	430	550	0
DB 2129	44	1549	1	475	398	740	900	19
DB 2554	47	1654	2	400	314	434	620	0
DB 2331	63	2218	2	400	314	440	820	0
DB 2478	78	2746	2	500	427	536	800	0
DB 2378	78	2746	2	400	314	440	1000	0

Spin-On Separators

To satisfy the specific technical requirements of some OEMs, Sotras has developed spin-on type air/oil separators which are often designed and personalized according to customers' requests. Choosing the internal components is to aim for the best solutions available on the market and no less attention is given to the external coating on the housing for which only the best quality paints are used and on which overprinting can be added to suit customers' instructions.

Quality is a priority at Sotras, so the important Material Stress Analysis Test is systematically carried out during study phases and on every production batch.

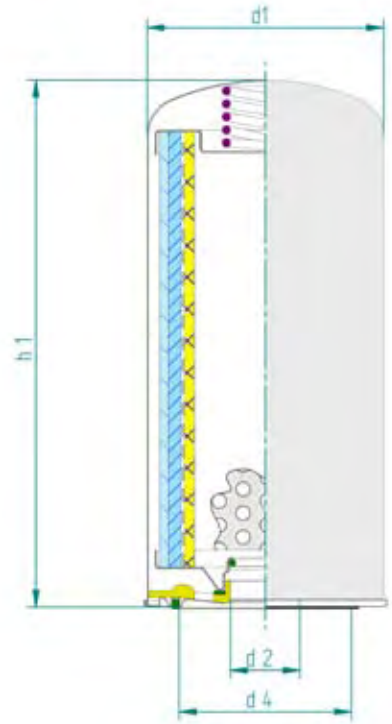

SOTRAS Ref.	*Nominal flow Rate		d1 (mm)	d2 (mm)	d4 (mm)	h1 (mm)
	m ³ /min	(cfm)				
DF 5010	1	35	76	M22X1,5	62	123
DF 5033	1	35	76	M22X1,75	62	123
DF 5062	1,2	42	96	M24X1,5	62	148
DF 5022	1,5	53	96	M24X1,5	62	173
DF 5005	2	70	96	M24X1,5	62	210
DF 5019	2	70	96	M24X1,75	62	210
DF 5044	2	70	96	1"12 UNF	62	210
DF 5013	2,7	95	108	M32X1,5	93	180
DF 5006	3	105	136	M39X1,5	99	177
DF 5038	3	105	136	M39X1,75	99	177
DF 5058	3	105	136	1"1/2-16UNF	99	177
DF 5056	4	140	136	M39X1,5	99	235
DF 5009	4	140	108	M32X1,5	93	260
DF 5025	4	140	108	M32X1,75	93	260
DF 5034	4	140	108	M33X1,5	93	260
DF 5043	4	140	108	1" 3/8 16 UNF	93	260
DF 5004	5,5	194	136	M39X1,5	99	303
DF 5045	5,5	194	136	1"1/2-16UNF	99	303
DF 5026	5,5	194	136	M39X1,75	99	303
DF 5041	6,4	225	136	M39X1,5	99	336

**The data is indicative and based on 7 bar working pressure*

The tables show the basics of the technical features. However a consultation of specific data sheets containing further detailed technical information, available at Sotras, is highly recommended to OEMs



Filter Heads & Adapters

For OEMs that use spin-on separators but do not make filter heads and adapters in house, we are able to offer different options.

Besides simple separator heads, Sotras is also able to provide models with integrated connectors for oil cartridges.

Depending on the OEM's requirements it is possible to order the filter head alone or together with the relevant elements - separator and oil filter.

On request, we provide information regarding heads with thermostatic valves, minimum pressure valves and visual oil indicators.

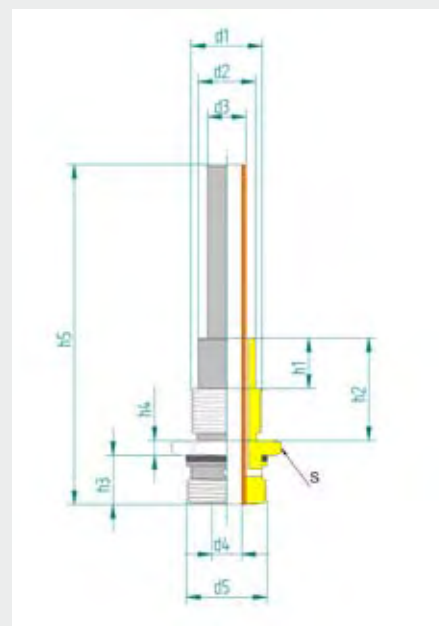

SOTRAS Ref.	d1	d2 (mm)	D3 (mm)	d4 (mm)	d5	h1 (mm)	h2 (mm)	h3 (mm)	h4 (mm)	h5 (mm)	S	Corresp. separator
NP 0001	M22X1,5	19,2	14	12	M27X1,5	16	32	18	5	115	32	DF 5010
NP 0002	M24X1,5	19,8	15	13	M27X1,5	16	32	18	5	195	32	DF 5005
NP 0003	M32X1,5	28,1	22	19	1"-1/4 G	20	41	18	5	137	50	DF 5009
NP 0004	M39X1,5	35,8	30	26,5	1"-1/4 G	20	41	18	5	155	50	DF 5004 DF 5006





Air Filters

Besides being able to provide a wide range of adaptable air cartridges, Sotras can offer OEMs a series of air filters that do not require a housing. These filters are recommended for 1 to 12 m³/min flow rates and can be installed vertically or horizontally.

This type of solution offers a low pressure drop, excellent filtration performance, and very simple installation and replacement procedures. (On specific requests we can offer fibreglass or oiled cellulose filtering media.)

Sotras can offer air filters available with plastic end caps in metal free configuration.

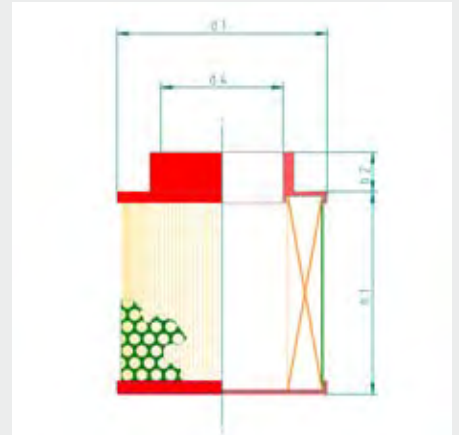

**The nominal flow rate refers to flow resistance of 10 mbar*

SOTRAS Ref.	*Nominal flow Rate	d1 (mm)	d4 (mm)	h1 (mm)	h2 (mm)
	m ³ /min				
SA 6663	3,3	110	51	93	25
SA 6972	3,3	110	41	93	25
SA 6620	6,8	130	76	125	25
SA 6696	7,7	164	76	135	25
SA 6905	7,7	164	60	135	25
SA 6718	12	230	100	116	35

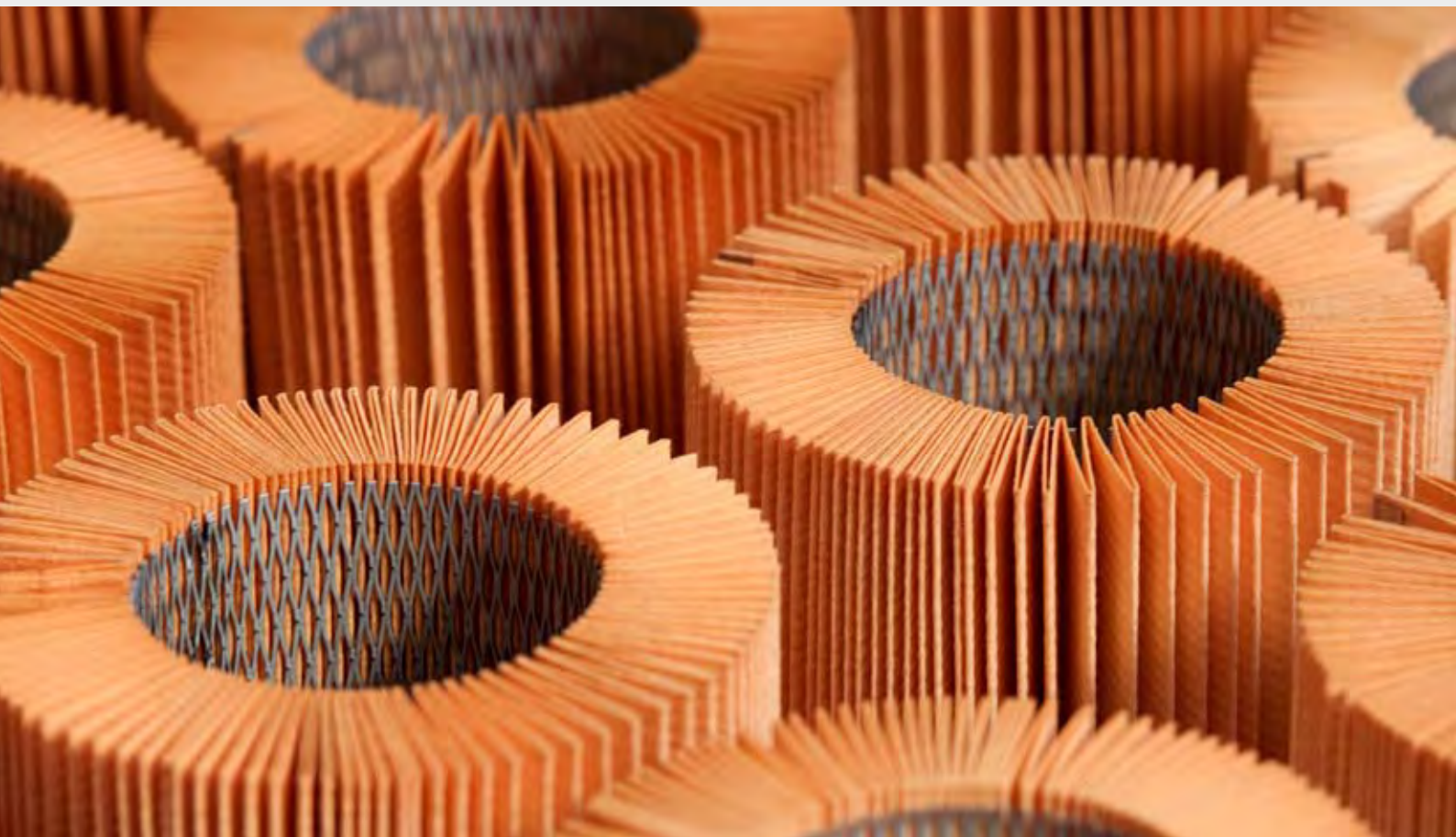

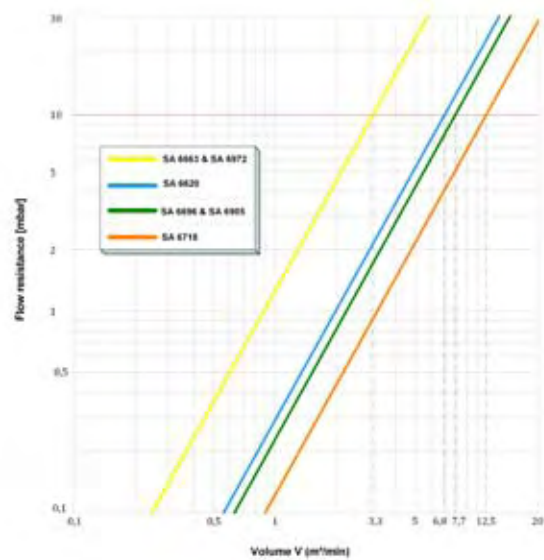
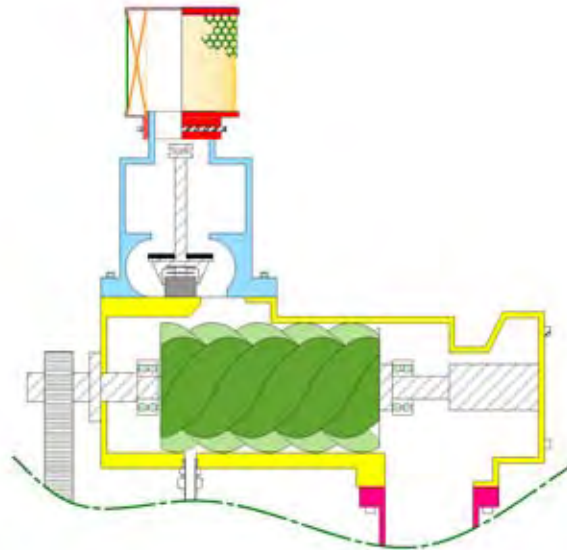

Air Filters

Air filters with metal end caps are available for those OEMs who require products withstanding particular stress conditions. The sealing is guaranteed by using a rubber gasket tightened with a special clamp.



**The nominal flow rate refers to flow resistance of 10 mbar*

SOTRAS Ref.	*Nominal flow Rate	d1 (mm)	d4 (mm)	h1 (mm)	h2 (mm)
	m ³ /min				
SA 7096	2	98	52	70	28
SA 7097	3	98	52	104	28
SA 7100	3	98	42	104	28
SA 7098	7,5	152	59	127	24
SA 7099	12,5	200	81	151	34

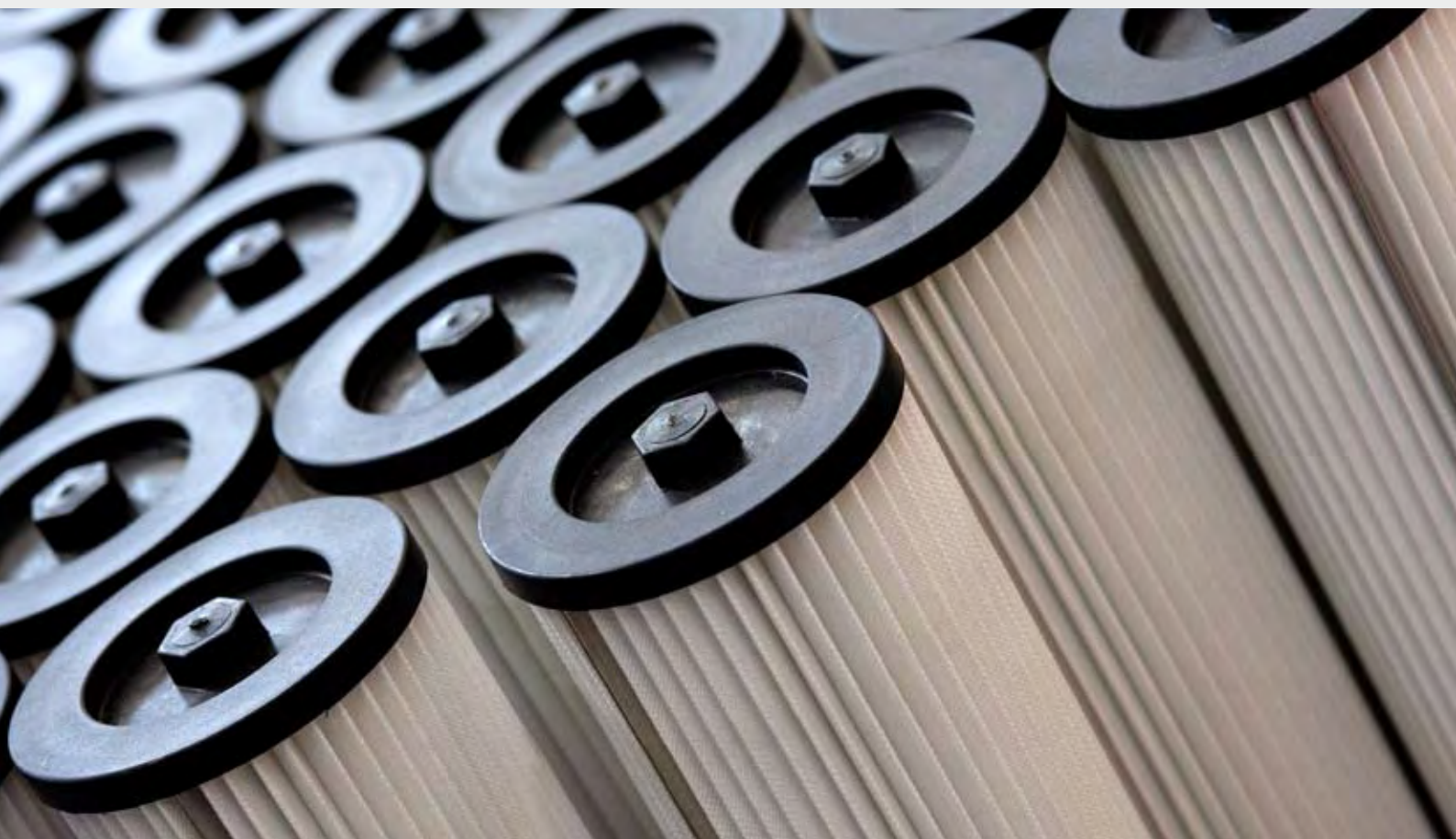

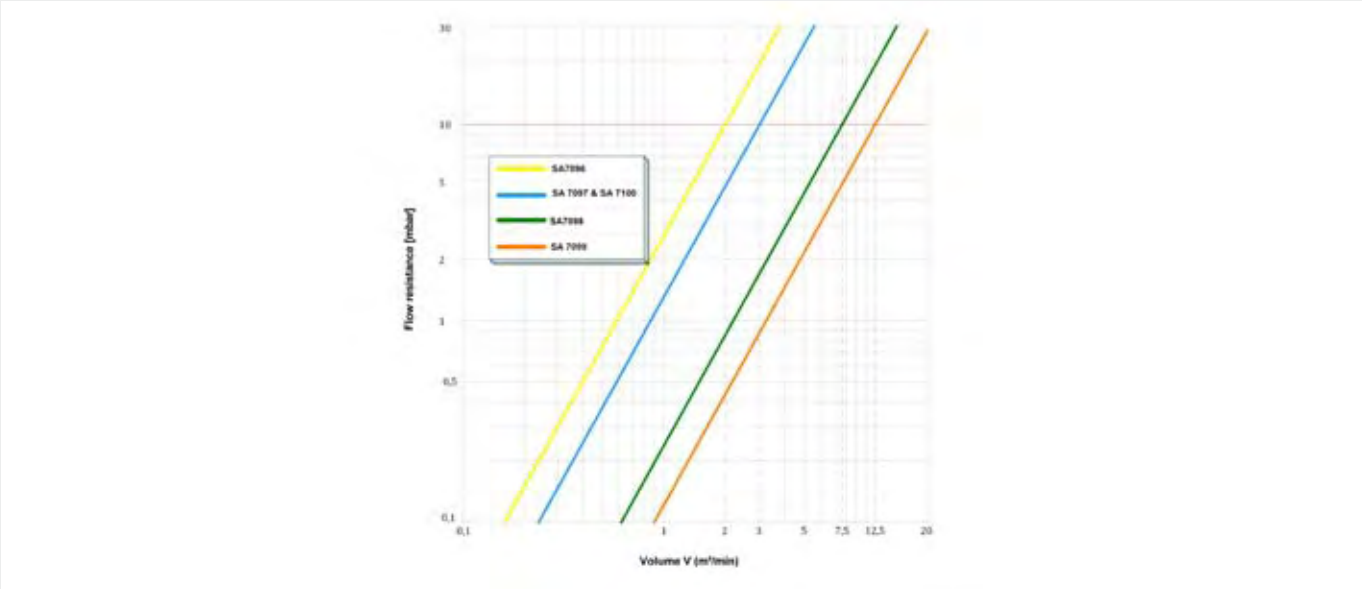
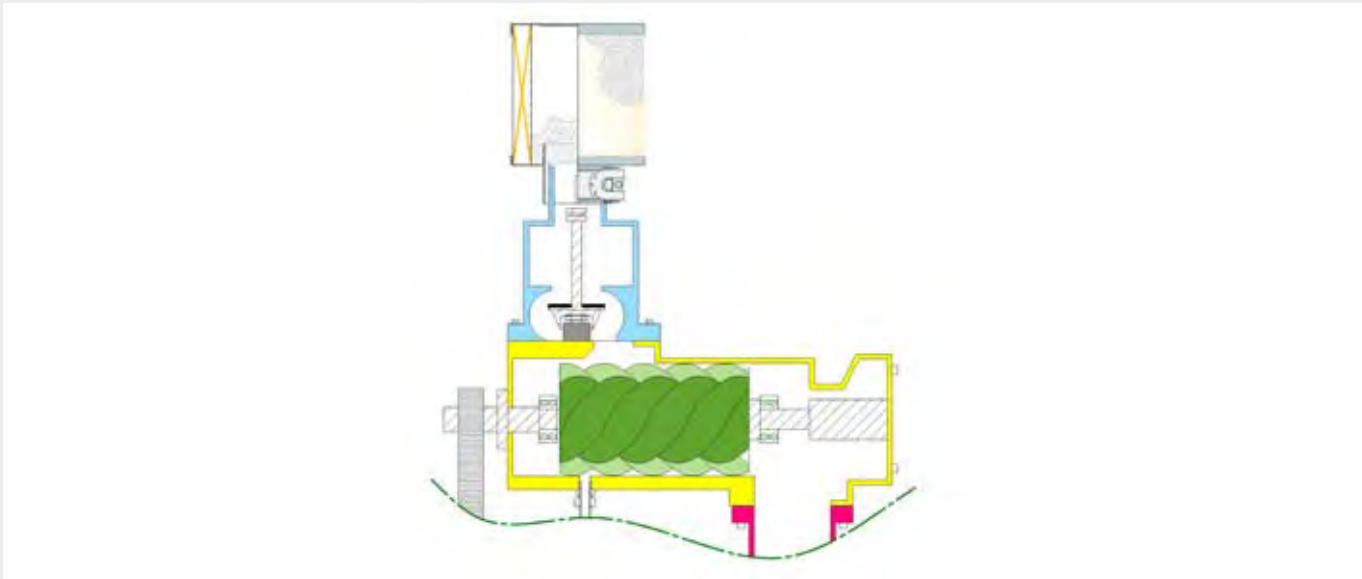

Plastic Air Cleaners

Suitable for low flow screw compressors and piston compressors

Plastic air cleaners guarantee excellent flexibility combined with high corrosion resistance, full recyclability and easy maintenance.

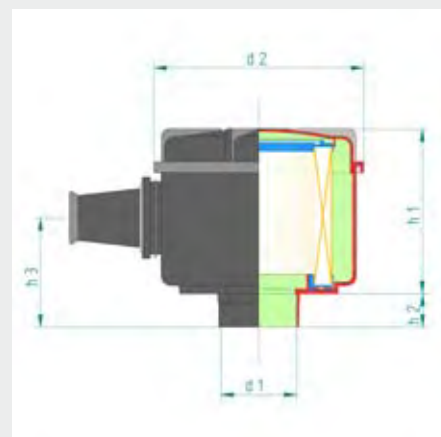

**The nominal flow rate refers to flow resistance of 15 mbar*

SOTRAS Ref.	d1 (mm)	d2 (mm)	h1 (mm)	h2 (mm)	h3 (mm)	(*) Nominal flow rate (m ³ /min)	Element.Ref.
SA 7145	40	112	85	24	57	1	SA 7146
SA 7143	52	144	113	23	75	2	SA 7144



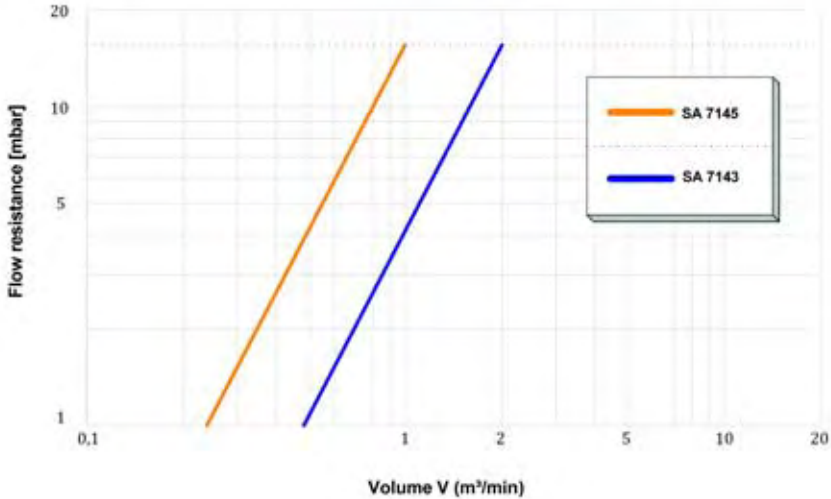

Spin-On Oil Filters

Thanks to its experience in the hydraulic sector, Sotras has developed a range of oil filters, especially suitable for screw and vane compressors and vacuum pumps applications, bearing in mind that these filters will have to endure sudden changes and extreme limits in pressure and temperature. The oil filters that Sotras offers are usually of the spin-on type and can be provided with a by-pass valve, if it is not already to be found on the heads or in the lubrication circuit.

Generally the most commonly used filtering media is made of cellulose, however fibreglass and metallic mesh versions are available on request.

Every batch undergoes stringent laboratory performance tests in terms of resistance to cyclic and maximum working pressure.

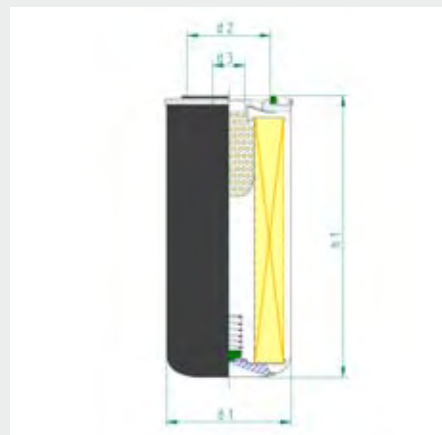

SOTRAS REF.	d1 (mm)	d2 (mm)	d3	h1 (mm)	Non-re-turn Valve (bar)	by-pass Valve (bar)	Nominal flow rate (l/min)	Max. operating Press. (bar)
SH 8256	93	62	M 20X1,5	97	-	3	10	25
SH 8118	76	62	3/4" 16-UNF	95	0,12	2,5	15	14
SH 8196	93	62	3/4" 16-UNF	58	0,12	0,8	15	14
SH 8227	76	62	3/4" 16-UNF	79	-	-	15	14
SH 8113	76	62	3/4" 16-UNF	125	0,12	2,5	20	14
SH 8152	76	62	3/4" 16-UNF	140	-	3,5	20	35
SH 8153	93	62	3/4" 16-UNF	97	-	2,5	25	25
SH 8221	76	62	M 20X1,5	119	-	0,6	25	14
SH 8206	93	62	3/4" 16-UNF	114	0,12	2,5	25	14
SH 8262	93	62	3/4" G	142	-	2,5	25	14
SH 8222	76	62	3/4" 16-UNF	123	0,12	2,5	30	14
SH 8226	93	62	3/4" 16-UNF	95	0,12	2,5	30	14
SH 8112	93	62	3/4" 16-UNF	143	0,12	2,5	40	14
SH 8119	93	62	1" 12-UNF	143	0,12	2,5	40	14
SH 8154	93	62	3/4" 16-UNF	144	-	2,5	40	25
SH 8155	93	62	1" 12-UNF	172	-	2,5	40	25
SH 8143	96	62	3/4" G	146	-	-	40	14
SH 8225	76	62	3/4" 16-UNF	123	0,12	2,5	40	14
SH 8146	93	62	1" 12-UNF	170	0,12	2,5	45	14
SH 8238	93	62	3/4" 16-UNF	142	-	-	50	14
SH 8224	93	62	1" 12-UNF	144	-	2,5	50	25
SH 8130	96	62	3/4" G	193	-	-	55	14



SOTRAS REF.	d1 (mm)	d2 (mm)	d3	h1 (mm)	Non-re-turn Valve (bar)	by-pass Valve (bar)	Nominal flow rate (l/min)	Max. operating Press. (bar)
SH 8147	93	62	1" 12-UNF	210	0,12	2,5	70	14
SH 8149	108	62	1" 12-UNF	210	0,12	1,2	70	14
SH 8107	93	62	1" 12-UNF	210	-	2,5	70	14
SH 8110	93	62	1" 12-UNF	212	-	2,5	70	25
SH 8150	93	62	M 20X1,5	212	-	2,5	70	30
SH 8144	127	98	1" 1/4 G	182	-	-	80	14
SH 8114	136	99	1" 1/2 16-UNF	177	-	-	95	20
SH 8108	108	93	1" 1/8 16-UNF	260	0,12	2,5	100	14
SH 8145	127	98	1" 1/4 G	228	-	-	150	12
SH 8109	136	100	1" 1/2 16-UNF	302	-	2,5	180	20
SH 8705	136	100	1" 1/2 16-UNF	308	-	2,5	180	14





Filters & Products for Vacuum Pumps

Standard Demisters

The media used in our separators enables us to obtain excellent air/oil separation rates up to 1-3 mg/m³.

All oil separators are manufactured using materials to withstand high pressures and temperatures and to minimise moisture induced deterioration.

In order to achieve the best possible separation efficiency and long working life of the element, it is essential that regular maintenance procedures are followed and joints are applied correctly, as well as the use of good quality air and oil filters.



SOTRAS Ref.	Nominal flow Rate		Fig.	d1 (mm)	d2 (mm)	d3 (mm)	h1 (mm)	h2 (mm)
	m ³ /min	(cfm)						
DA 1123	0,10	3,5	2	35	G 3/8"	-	55	10
DA 1399	0,15	5,3	5	54	25	29	40	4
DA 1124	0,20	7,0	2	35	G 3/8"	-	84	10
DA 1125	0,25	8,8	2	35	G 3/8"	-	109	10
DA 1050	0,30	10,6	1	55	25	-	68	4
DA 1139	0,30	10,6	3	40	20	20	96	-
DA 1148	0,30	10,6	5	54	25	29	79	4
DA 1241	0,30	10,6	6	55	M25X2	-	76	13
DA 1051	0,40	14,1	1	72	32	-	74	4
DA 1130	0,40	14,1	2	52	28	-	120	8
DA 1280	0,40	14,1	5	54	25	29	95	4
DA 1067	0,50	17,6	1	55	25	-	124	4
DA 1238	0,50	17,6	6	72	M32X2	-	82	13
DA 1103	0,55	19,4	3	64	44	-	99	3
DA 1400	0,60	21,1	5	80	48	35	102	5
DA 1128	0,60	21,1	3	56	24	6	153	-
DA 1022	0,70	24,6	1	80	45	-	118	5
DA 1206	0,70	24,6	5	54	25	29	175	4
DA 1060	0,80	28,2	2	72	35	-	132	8
DA 1094	0,80	28,2	2	53	28	-	200	8
DA 1061	0,80	28,2	4	72	35	-	132	8
DA 1239	0,80	28,2	6	80	M45X3	-	127	14
DA 1120	0,90	31,7	3	79	46	46	144	-
DA 1111	1,20	42,2	2	72	35	8,5	200	8
DA 1091	1,25	44,0	4	72	35	-	208	8
DA 1185	1,30	45,8	5	80	48	35	200	5
DA 1068	1,30	45,8	3	66	41	6	228	-

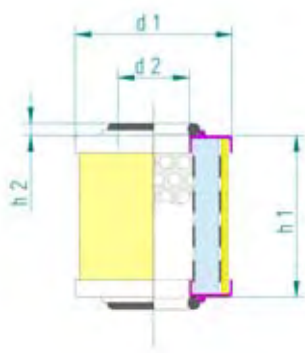

fig. 1

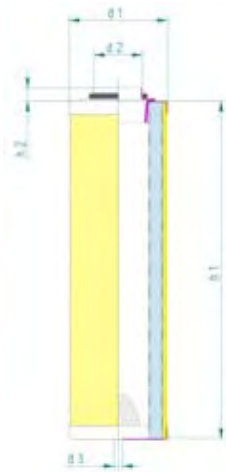

fig. 2

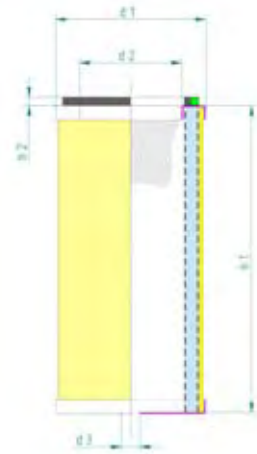

fig. 3

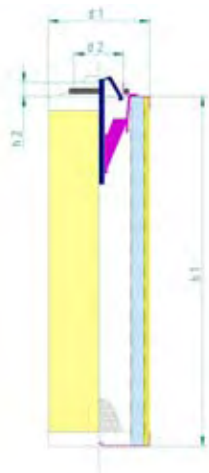

fig. 4



fig. 5

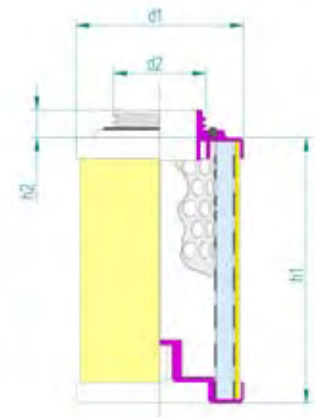

fig. 6

SOTRAS Ref.	Nominal flow Rate		Fig.	d1 (mm)	d2 (mm)	d3 (mm)	h1 (mm)	h2 (mm)
	m ³ /min	(cfm)						
DA 1047	1,50	52,8	2	72	35	-	250	8
DA 1052	1,50	52,8	4	72	35	-	250	8
DA 1110	1,50	52,8	2	72	35	8,5	250	8
DA 1086	1,80	63,4	3	70	40	40	330	-
DA 1254	2,00	70,4	3	100	63	6,5	251	6
DA 1020	2,20	77,4	3	106	72	72	218	(6 X 2)
DA 1048	2,20	77,4	2	72	35	-	375	8
DA 1053	2,20	77,4	4	72	35	-	375	8
DA 1069	2,30	81,0	3	66	41	6	397	-
DA 1187	2,50	88,0	2	82	50	9,5	380	8
DA 1253	2,50	88,0	3	100	63	6,5	293	6
DA 1108	2,60	91,5	5	80	48	35	400	5
DA 1030	2,80	98,6	3	106	72	72	284	(6 X 2)
DA 1049	2,90	102,1	2	72	35	-	500	8
DA 1054	3,00	105,6	4	72	35	-	500	8
DA 1135	3,60	126,7	2	82	50	9,5	536	8

Vacuum Air Filters

Sotras offers a wide range of filters to suit most requirements in this field and the elements are usually interchangeable with those produced by other leading manufacturers.

Steel housings are treated with a special protective coating thereby guaranteeing a longer durability. They also undergo thorough tests to ensure the seals withstanding high vacuum levels.

The elements have high dust retention and are available with paper media (having a normal filtration rate of 5 microns) as well as glassfibre media for special applications.

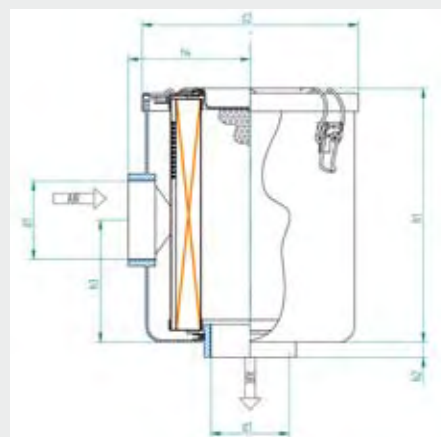

SOTRAS Ref.	d1	MALE FEMALE	d2 (mm)	h1 (mm)	h2 (mm)	h3 (mm)	h4 (mm)	Nominal flow rate (m ³ /min)	Element.Ref.
SA 6654	G 3/8"	F	80	66	12	39	45	0,4	SA 6715
SA 6058	G 3/4"	F	110	76	14	53	54	0,7	SA 6091
SA 6647	G 1/2"	F	110	76	14	53	54	0,7	SA 6091
SA 6952	G 1"	F	133	85	17	53	78	1,4	SA 6120
SA 6059	G 1 1/4"	F	133	85	17	53	78	1,6	SA 6120
SA 6819	1 1/4 NPT	F	133	85	17	53	78	1,6	SA 6120
SA 6061	G 1 1/4"	F	170	141	17	93	96	1,8	SA 6122
SA 6635	G 1 1/4"	M	170	141	17	93	96	1,8	SA 6122
SA 6820	1 1/4 NPT	F	170	141	17	93	96	1,8	SA 6122
SA 6821	1 1/2 NPT	F	170	141	17	93	96	1,8	SA 6122
SA 6648	G 1 1/2"	F	170	170	18	124	100	3,2	SA 6651
SA 6822	1 1/2 NPT	F	170	170	18	124	100	3,2	SA 6651
SA 6649	G 2"	F	200	240	18	124	114	5,2	SA 6096
SA 6823	2" NPT	F	200	240	18	124	114	5,2	SA 6096
SA 6060	G 2 1/2"	F	200	240	18	124	114	6,0	SA 6096
SA 6824	2 1/2 NPT	F	200	240	18	124	114	6,0	SA 6096
SA 6650	G 3"	F	270	180	50	145	165	9,2	SA 6095
SA 6652	G 4"	F	270	180	50	145	165	12,0	SA 6095
SA 6825	4" NPT	F	270	180	50	145	165	12,0	SA 6095
SA 6749	G 3"	F	280	395	50	330	190	18,0	SA 6005
SA 6750	G 4"	F	360	590	50	400	230	21,0	SA 6025

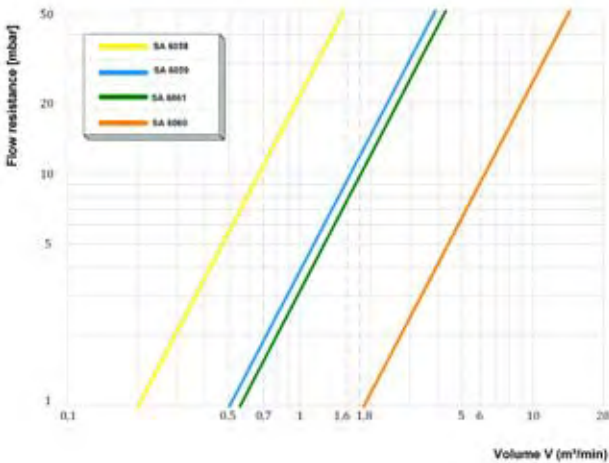
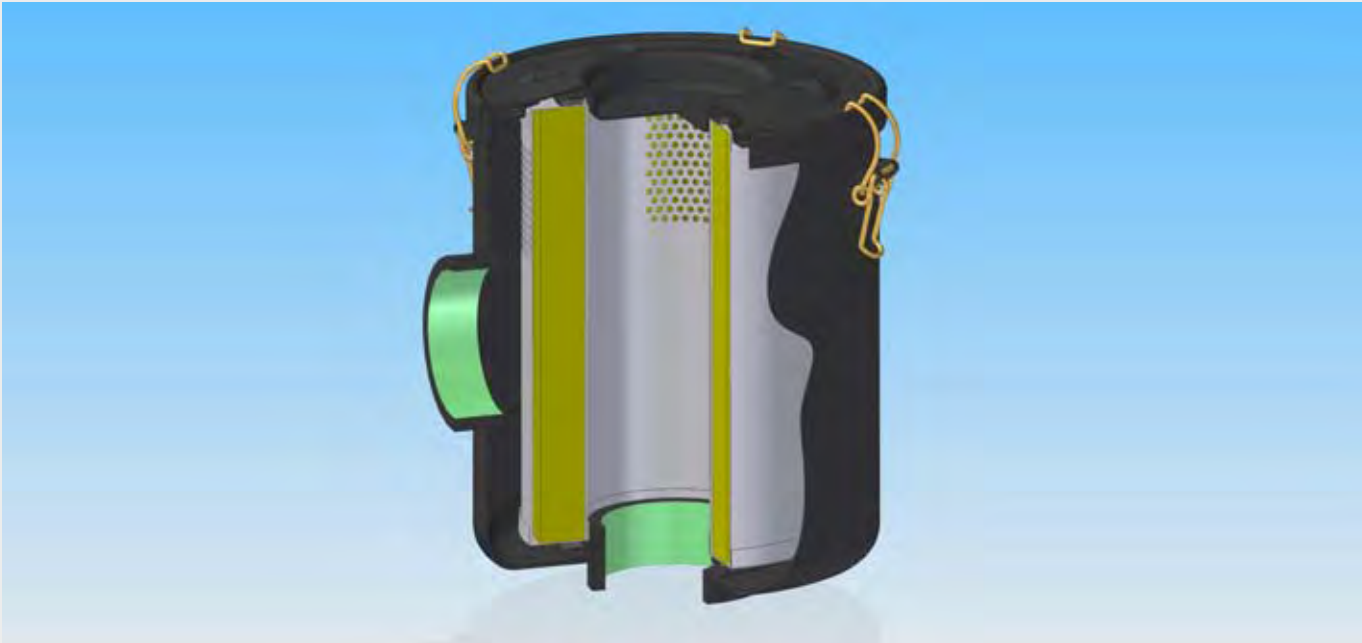





Filters & Products for Vacuum and Compressed Air

Compressed Air Filters

Due to the continuous demand of users of compressed air for clean, high quality air, Sotras offers a range of coalescing filters specifically designed to suit most requirements. Our established experience enables us to offer simple, efficient and high quality products at competitive prices. There are four series of elements available for various types of applications, depending on the level of filtration required.

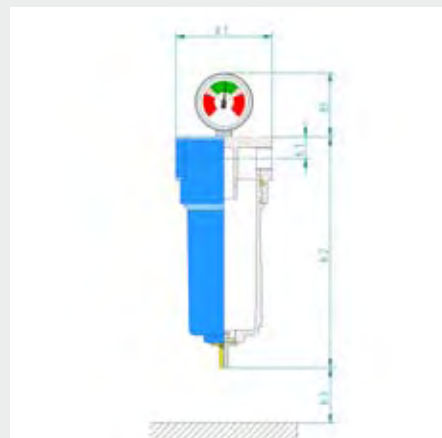

Sotras also offers a wide range of alternative elements suitable for other makes of housings

SOTRAS Ref.	Capacity (m ³ /h at 7 bar)	Connections	D1 (mm)	H1 (mm)	H2 (mm)	H3 (mm)	Max operating pressure (bar)
SM 9001	60	3/8"	87	21	209	75	16
SM 9002	78	1/2"	87	21	209	75	16
SM 9003	120	3/4"	87	21	279	160	16
SM 9004	198	1"	130	43	315	135	16
SM 9005	335	1"	130	43	415	235	16
SM 9006	510	1 1/2"	130	43	515	335	16
SM 9007	780	1 1/2"	130	43	715	525	16
SM 9008	1000	2"	164	48	823	520	16
SM 9009	1500	2"	164	48	1073	770	16
SM 9010	2760	3"	250	74	1202	780	12

FILTER HOUSING	ELEMENT			
	PREFILTER (series 1)	FINE FILTER (series 2)	MICROFILTER (series 3)	ACT.CARB. (series 4)
SM 9001	SM 9017	SM 9018	SM 9019	SM 9020
SM 9002	SM 9021	SM 9022	SM 9023	SM 9024
SM 9003	SM 9025	SM 9026	SM 9027	SM 9028
SM 9004	SM 9029	SM 9030	SM 9031	SM 9032
SM 9005	SM 9033	SM 9034	SM 9035	SM 9036
SM 9006	SM 9037	SM 9038	SM 9039	SM 9040
SM 9007	SM 9041	SM 9042	SM 9043	SM 9044
SM 9008	SM 9045	SM 9046	SM 9047	SM 9048
SM 9009	SM 9049	SM 9050	SM 9051	SM 9052
SM 9010	SM 9053	SM 9054	SM 9055	SM 9056

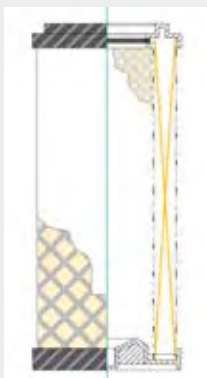

PRE FILTERS
"Series 1"

Coarse filtration and dust removal.
Air flow through filter element - in to out

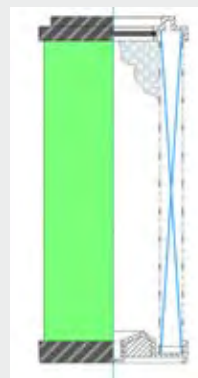

FINE FILTERS
"Series 2"

General purpose protection Particle removal down to 0,1 micron.
Maximum residual oil content down to 0,5 PPM.
Air flow through filter element - in to out.

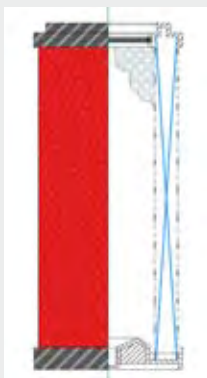

MICRO FILTERS
"Series 3"

High efficiency Particle removal down to 0,01 micron.
Maximum residual oil content down to 0,01 PPM.
Air flow through filter element - in to out.

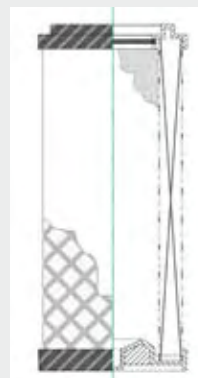

ACTIVATED CARBON FILTERS
"Series 4"

Oil vapour and odour removal Particle removal below 0,01 micron.
Maximum residual oil content down to 0,005 PPM.
Air flow through filter element - in to out.

SERIES	PARTICLE REMOVAL DOWN TO (micron)	OIL REMOVAL DOWN TO (mg/m ³)	NOMINAL INITIAL PRESSURE DROP (bar g)
1	3	-	0,03
2	0,1	0,5	0,05
3	0,01	0,01	0,06
4	0,01	0,005	0,12

Accessories & Kits

Sotras has developed and offers a series of service kits on customer's request.



Practical Advice

Our products regularly undergo stringent quality control checks and only very seldom has the malfunctioning of the compressor been ascribed to the element.

Here below are listed some of the most common causes which lead on to an improper functioning of the machine.

Premature increase in pressure differential

This usually occurs when compressors work under the following conditions:

- a) Air intake filter and oil no longer efficient
- b) Unsuitable or heavily contaminated oil
- c) Water contamination-recognised by rust deposits in separator tank.

To help in avoiding these problems, there should be frequent replacements of the Air and Oil filters and the oil should be changed completely at regular intervals. Check for deposits of 'varnish' which can quickly block a separator. Compressor should not be run at excessively high temperatures.

Excessive use of oil

This normally occurs under the following circumstances:

- a) Separator not changed at the appropriate time. If the separator has reached the end of its lifespan or has worked in arduous conditions and is not replaced, it can suffer structural damage (collapse) or media breakdown causing oil carry-over.
- b) Blocked or malfunctioning scavenge tube. This situation increases the level of oil inside the separator and the amount of oil carry-over. To avoid this problem, the scavenge tube must be checked for correct length at every separator change and kept free from blockage.
- c) Incorrect oil level in tank. Overfilling with oil alters the pre-separation process and increases the quantity of oil in the air/oil mist thereby reducing the efficiency of the separator. "Foaming" created by the oil can also create this situation.
- d) Gaskets applied incorrectly or use of unsuitable or used gaskets. When installing a new separator the incorrect application of joints (bad seal) can cause heavy movements of oil thereby by-passing the separating system.
- e) Inefficient separation system. In some instances, the design of the compressor separation system is inefficient. In these cases the manufacturers improve the separation efficiency by adding baffles or through modification of separations by adding pre-separation media to the outside of the element.

Collapsed separator causes

This normally occurs under the following circumstances:

- a) Separator excessively contaminated
- b) Sudden surges caused by:
 - malfunctioning valves
 - sudden release of air to atmosphere (mobile compressors)
- c) Rotary compressors working in parallel with reciprocating compressors without a suitable air receiver.

Flash fires

These are very rare and are caused by several factors occurring simultaneously and not directly related to the Air/Oil separator.

It is good practice to ensure that the gaskets have a reliable form of grounding by the use of suitable materials (at least one or two metal staples or metal foil) so that there is contact between the element and the separator tank.

There are many causes of high discharge air temperature in a compressor. Any one can lead to a fire. Some of those causes include:

- loss of lubricant,
- clogging of lubricant orifices to the screws,
- failure of the oil stop valve, clogging of coolant lines,
- fouling of radiator cooling fans (air cooled compressors),
- clogging of oil filter,
- dirty oil,
- low lubricant levels,
- lubricant oxidized or varnished,
- malfunctioning oil temperature control valve,
- failure of cooling fan, and lack of proper ventilation to compressor.

The discharge air temperature switch is designed to shut down the machine if a cooling problem exists in the compressor. These switches are normally set to trip when the air temperature reaches 110° to 115°C (230° to 240°F).

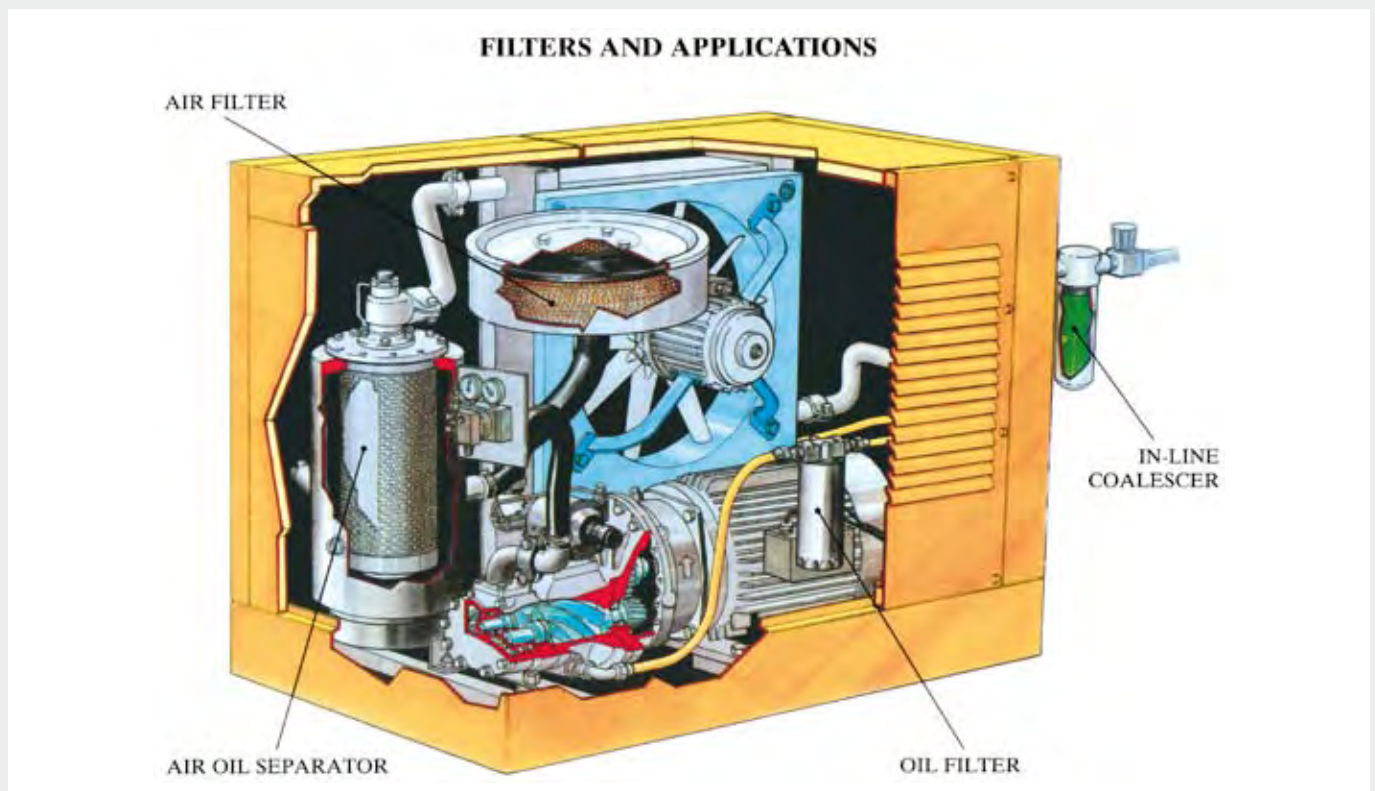

If the switch is inoperative or defective, the compressor will continue to run and a fire may ensue.

The autoignition temperature is the minimum temperature required to cause self-sustained combustion in the liquid in the absence of a spark or flame. The important point here is that the liquid will burn at or above its autoignition temperature and no additional energy is necessary to initiate this action. Mineral-based lubricating oils display autoignition temperatures of about 240° to 280°C (464° to 536°F) at atmospheric pressure. A reduction in their autoignition temperatures is observed at elevated pressures.

The fire may be vented to the surroundings through piping between the stator and sump, or orifices in the sump, such as safety valves and air couplings. Other mechanisms are believed to have caused fires-in compressor. They are considered to be low probability events, but they have occurred in industry.

Three situations that can cause a fire or explosion in the separator area are listed.

1. Small holes or partial clogging in the coalescing filter can result in the passage of high velocity air. This causes the filter to heat, providing an ignition source for the air/oil mist that passes through. Clogging of the filter has been the reported cause of at least one compressor fire.
2. In older compressors where the coalescing filter was ungrounded, static discharge between the sump and the filter was mentioned as a possible ignition source for fires. Newer models incorporate a coalescing filter with staples in the gasket. These effectively ground the filter to the separator tank. Addition of these staples has reportedly eliminated this type of flash fire mechanism.
3. The coalescing filter can become saturated with oil if the compressor runs unloaded over a period of time. Since the amount of cooling air passing through the filter is reduced, self-heating of the oil in the filter can occur and lead to a fire.

Quality and Guarantee

We would like to emphasise that Sotras filters undergo stringent quality control and are frequently tested in order to ensure satisfactory operation in the application of which they are designed.

Evidence of the high quality of our products lies in the fact that Sotras manufactures original equipment for some of the most important compressor manufacturers, to some of which Sotras guarantees product exclusivity.

We guarantee that filters produced by Sotras are free from defects either in materials or construction, always provided that the machinery is maintained in accordance with manufacturer's recommendations and filters are correctly installed and changed.

Sotras will replace any item found to be defective as described above but will not be held responsible for any other replacement or contingencies or consequential loss.

Sotras' organization has been certified for its quality management systems since 1999.

Its first certification was in compliance with UNI EN ISO 9002-94.

In 2003, Sotras has obtained a new certification to UNI EN ISO 9001-2000 and in 2009 to UNI EN ISO 9001-2008.

In 2003 Sotras' products have been certified in compliance with GOST-R regulations for the Russian market.



SOTRAS

Via Donatello, 13
10071 Borgaro Torinese - Italy
T +39.011.262.22.22
F +39.011.262.41.41
www.sotras.com
info@sotras.com